

HIGHLIGHTS OF PRESCRIBING INFORMATION

These highlights do not include all the information needed to use EXELON safely and effectively. See full prescribing information for EXELON.

EXELON® (rivastigmine tartrate) capsules, for oral use

EXELON® (rivastigmine tartrate) oral solution

Initial U.S. Approval: 2000

-----RECENT MAJOR CHANGES-----

Dosage and Administration (2.4)	1/2015
Warnings and Precautions, Allergic Dermatitis (5.2)	1/2015

-----INDICATIONS AND USAGE-----

EXELON is an acetylcholinesterase inhibitor indicated for treatment of:

- Mild to moderate dementia of the Alzheimer's type (1.1)
- Mild to moderate dementia associated with Parkinson's disease (1.2)

-----DOSAGE AND ADMINISTRATION-----

Alzheimer's Disease:

- Initiate treatment with 1.5 mg twice a day
- After a minimum of 2 weeks, if tolerated, increase dose to 3 mg twice a day and further to 4.5 mg twice a day and 6 mg twice a day if tolerated with a minimum of 2 weeks at each dose (2.1)

Parkinson's Disease Dementia:

- Initiate treatment with 1.5 mg twice a day
- After a minimum of 4 weeks, if tolerated, increase dose to 3 mg twice a day and further to 4.5 mg twice a day and 6 mg twice a day if tolerated with a minimum of 4 weeks at each dose (2.2)

EXELON should be taken with meals in divided doses in the morning and evening. (2.1, 2.2) EXELON Oral Solution and EXELON Capsules may be interchanged at equal doses (2.4)

-----DOSAGE FORMS AND STRENGTHS-----

- Capsules: 1.5 mg, 3 mg, 4.5 mg, or 6 mg (3.1)
- Oral solution: 2 mg/mL (3.2)

FULL PRESCRIBING INFORMATION: CONTENTS*

1 INDICATIONS AND USAGE

- 1.1 Alzheimer's Disease
- 1.2 Parkinson's Disease Dementia

2 DOSAGE AND ADMINISTRATION

- 2.1 Dosing in Alzheimer's Disease
- 2.2 Dosing in Parkinson's Disease Dementia
- 2.3 Interruption of Treatment
- 2.4 Dosing in Specific Populations
- 2.5 Important Administration Instructions

3 DOSAGE FORMS AND STRENGTHS

- 3.1 EXELON Capsules
- 3.2 EXELON Oral Solution

4 CONTRAINDICATIONS

5 WARNINGS AND PRECAUTIONS

- 5.1 Gastrointestinal Adverse Reactions
- 5.2 Allergic Dermatitis
- 5.3 Other Adverse Reactions from Increased Cholinergic Activity
- 5.4 Impairment in Driving or Use of Machinery

6 ADVERSE REACTIONS

- 6.1 Clinical Trials Experience
- 6.2 Postmarketing Experience

7 DRUG INTERACTIONS

- 7.1 Metoclopramide

-----CONTRAINDICATIONS-----

- Known hypersensitivity to rivastigmine, other carbamate derivatives or other components of the formulation (4)
- History of application site reaction with rivastigmine transdermal patch suggestive of allergic contact dermatitis, in the absence of negative allergy testing (4, 5.2)

-----WARNINGS AND PRECAUTIONS-----

- Gastrointestinal adverse reactions may include significant nausea, vomiting, diarrhea, anorexia/decreased appetite, and weight loss, and may necessitate treatment interruption. Dehydration may result from prolonged vomiting or diarrhea and can be associated with serious outcomes (5.1)
- Discontinue rivastigmine in case of disseminated allergic dermatitis, which may occur after oral or transdermal administration. (4, 5.2) In patients with suspected allergic contact dermatitis after transdermal rivastigmine use, switch to oral rivastigmine only after negative allergy testing.

-----ADVERSE REACTIONS-----

Most common adverse reactions (>5% and 2 times greater than placebo): nausea, vomiting, anorexia, dyspepsia, and asthenia (6.1)

To report SUSPECTED ADVERSE REACTIONS, contact Novartis Pharmaceuticals Corporation at 1-888-669-6682 or FDA at 1-800-FDA-1088 or www.fda.gov/medwatch.

-----DRUG INTERACTIONS-----

Concomitant use with metoclopramide, beta-blockers, or cholinomimetic and anticholinergic drugs is not recommended (7.1, 7.2, 7.3)

See 17 for PATIENT COUNSELING INFORMATION and FDA-approved patient labeling.

Revised: 1/2015

7.2 Cholinomimetic and Anticholinergic Medications

7.3 Beta-blockers

8 USE IN SPECIFIC POPULATIONS

- 8.1 Pregnancy
- 8.3 Nursing Mothers
- 8.4 Pediatric Use
- 8.5 Geriatric Use
- 8.6 Renal Impairment
- 8.7 Hepatic Impairment
- 8.8 Low or High Body Weight

10 OVERDOSAGE

11 DESCRIPTION

12 CLINICAL PHARMACOLOGY

- 12.1 Mechanism of Action
- 12.2 Pharmacodynamics
- 12.3 Pharmacokinetics

13 NONCLINICAL TOXICOLOGY

- 13.1 Carcinogenesis, Mutagenesis, Impairment of Fertility

14 CLINICAL STUDIES

16 HOW SUPPLIED/STORAGE AND HANDLING

17 PATIENT COUNSELING INFORMATION

* Sections or subsections omitted from the full prescribing information are not listed.

FULL PRESCRIBING INFORMATION

1 INDICATIONS AND USAGE

1.1 Alzheimer's Disease

EXELON is indicated for the treatment of mild to moderate dementia of the Alzheimer's type.

1.2 Parkinson's Disease Dementia

EXELON is indicated for the treatment of mild to moderate dementia associated with Parkinson's disease.

2 DOSAGE AND ADMINISTRATION

2.1 Dosing in Alzheimer's Disease

EXELON should be taken with meals in divided doses in the morning and evening.

The recommended dosage of EXELON Oral Solution and Capsules in Alzheimer's disease is 6 mg to 12 mg per day, administered twice a day (daily doses of 3 mg to 6 mg twice a day). There is evidence from the clinical trials that doses at the higher end of this range may be more beneficial.

Initial Dose

Initiate treatment with the 1.5 mg twice a day with EXELON.

Dose Titration

After a minimum of 2 weeks and if well tolerated, increase the dose to 3 mg twice a day. Subsequent increases to 4.5 mg twice a day and 6 mg twice a day should be attempted after a minimum of 2 weeks at the previous dose and if well tolerated. The maximum dose is 6 mg twice a day (12 mg per day).

2.2 Dosing in Parkinson's Disease Dementia

EXELON should be taken with meals in divided doses in the morning and evening.

The dosage of EXELON shown to be effective in the single controlled clinical trial conducted in dementia associated with Parkinson's disease is 3 mg to 12 mg per day, administered twice a day (daily doses of 1.5 mg to 6 mg twice a day).

Initial Dose

Initiate treatment with the 1.5 mg twice a day with EXELON.

Dose Titration

After a minimum of 4 weeks and if well tolerated, increase the dose to 3 mg twice a day. Subsequent increases to 4.5 mg twice a day and 6 mg twice a day should be attempted after a minimum of 4 weeks at the previous dose and if well tolerated. The maximum dose is 6 mg twice a day (12 mg per day).

2.3 Interruption of Treatment

If adverse effects (e.g., nausea, vomiting, abdominal pain, loss of appetite) cause intolerance during treatment, the patient should be instructed to discontinue treatment for several doses and then restart at the same or next lower dose level.

If dosing is interrupted for 3 days or fewer, restart treatment with the same or lower dose of EXELON. If dosing is interrupted for more than 3 days, treatment should be restarted with 1.5 mg twice a day and titrated as described above [*see Warnings and Precautions (5.1)*].

2.4 Dosing in Specific Populations

Dosing Modifications in Patients with Renal Impairment

Patients with moderate and severe renal impairment may be able to only tolerate lower doses.

Dosing Modifications in Patients with Hepatic Impairment

Patients with mild (Child-Pugh score 5 to 6) and moderate (Child-Pugh score 7 to 9) hepatic impairment may be able to only tolerate lower doses. No data are available on the use of rivastigmine in patients with severe hepatic impairment.

Dosing Modifications in Patients with Low Body Weight

Carefully titrate and monitor patients with low body weight (less than 50 kg) for toxicities (e.g., excessive nausea, vomiting), and consider reducing the dose if such toxicities develop.

2.5 Important Administration Instructions

Caregivers should be instructed in the correct procedure for administering EXELON Oral Solution. In addition, they should be directed to the Instruction Sheet (included with the product) describing how the solution is to be administered. Caregivers should direct questions about the administration of the solution to either their physician or pharmacist [*see Patient Counseling Information (17)*].

Patients should be instructed to remove the oral dosing syringe provided in its protective case, and using the provided syringe, withdraw the prescribed amount of EXELON Oral Solution from the container. Each dose of EXELON Oral Solution may be swallowed directly from the syringe or first mixed with a small glass of water, cold fruit juice, or soda. Patients should be instructed to stir and drink the mixture.

EXELON Oral Solution and EXELON Capsules may be interchanged at equal doses.

3 DOSAGE FORMS AND STRENGTHS

3.1 EXELON Capsules

Capsules, containing rivastigmine tartrate equivalent to 1.5 mg, 3 mg, 4.5 mg, or 6 mg of rivastigmine base, are available as follows:

- 1.5 mg capsule – yellow, “Exelon 1,5 mg” is printed in red on the body of the capsule.
- 3 mg capsule – orange, “Exelon 3 mg” is printed in red on the body of the capsule.
- 4.5 mg capsule – red, “Exelon 4,5 mg” is printed in white on the body of the capsule.
- 6 mg capsule – orange and red, “Exelon 6 mg” is printed in red on the body of the capsule.

3.2 EXELON Oral Solution

Oral Solution is a clear yellow, solution containing rivastigmine tartrate equivalent to 2 mg/mL of rivastigmine base. For a full list of excipients, see *Description (11)*.

4 CONTRAINDICATIONS

EXELON is contraindicated in patients with:

- known hypersensitivity to rivastigmine, other carbamate derivatives or other components of the formulation [*see Description (11)*].
- a previous history of application site reaction with rivastigmine transdermal patch suggestive of allergic contact dermatitis, in the absence of negative allergy testing [*see Warnings and Precautions (5.2)*].

Isolated cases of generalized skin reactions have been described in postmarketing experience [*see Adverse Reactions (6.2)*].

5 WARNINGS AND PRECAUTIONS

5.1 Gastrointestinal Adverse Reactions

EXELON can cause gastrointestinal adverse reactions, including significant nausea, vomiting, diarrhea, anorexia/decreased appetite, and weight loss. Dehydration may result from prolonged vomiting or diarrhea and can be associated with serious outcomes. The incidence and severity of these reactions are dose-related [*see Adverse Reactions*].

(6.1)]. For this reason, patients should always be started at a dose of 1.5 mg twice a day and titrated to their maintenance dose.

If treatment is interrupted for longer than 3 days, treatment should be reinitiated with the lowest daily dose [see *Dosage and Administration (2.1)*] to reduce the possibility of severe vomiting and its potentially serious sequelae (e.g., there has been one postmarketing report of severe vomiting with esophageal rupture following inappropriate reinitiation of treatment with a 4.5-mg dose after 8 weeks of treatment interruption).

Inform caregivers to monitor for gastrointestinal adverse reactions and to inform the physician if they occur. It is critical to inform caregivers that if therapy has been interrupted for more than 3 days because of intolerance, the next dose should not be administered without contacting the physician regarding proper retitration.

5.2 Allergic Dermatitis

There have been isolated postmarketing reports of patients experiencing disseminated allergic dermatitis when administered rivastigmine irrespective of the route of administration (oral or transdermal). Treatment should be discontinued if disseminated allergic dermatitis occurs [see *Contraindications (4)*]. Patients and caregivers should be instructed accordingly [see *Patient Counseling Information (17)*].

In patients who develop application site reactions suggestive of allergic contact dermatitis to EXELON PATCH and who still require rivastigmine, treatment should be switched to oral rivastigmine only after negative allergy testing and under close medical supervision. It is possible that some patients sensitized to rivastigmine by exposure to rivastigmine patch may not be able to take rivastigmine in any form.

5.3 Other Adverse Reactions from Increased Cholinergic Activity

Neurologic Effects

Extrapyramidal Symptoms: Cholinomimetics, including rivastigmine may exacerbate or induce extrapyramidal symptoms. Worsening of parkinsonian symptoms, particularly tremor, has been observed in patients with dementia associated with Parkinson's disease who were treated with EXELON Capsules.

Seizures: Drugs that increase cholinergic activity are believed to have some potential for causing seizures. However, seizure activity also may be a manifestation of Alzheimer's disease.

Peptic Ulcers/Gastrointestinal Bleeding

Cholinesterase inhibitors, including rivastigmine, may be expected to increase gastric acid secretion due to increased cholinergic activity. Monitor patients using EXELON for symptoms of active or occult gastrointestinal bleeding, especially those at increased risk for developing ulcers, e.g., those with a history of ulcer disease or those receiving concurrent nonsteroidal anti-inflammatory drugs (NSAIDs). Clinical studies of rivastigmine have shown no significant increase, relative to placebo, in the incidence of either peptic ulcer disease or gastrointestinal bleeding.

Use with Anesthesia

Rivastigmine, as a cholinesterase inhibitor, is likely to exaggerate succinylcholine-type muscle relaxation during anesthesia.

Cardiac Conduction Effects

Because rivastigmine increases cholinergic activity, use of rivastigmine may have vagotonic effects on heart rate (e.g., bradycardia). The potential for this action may be particularly important in patients with sick sinus syndrome or other supraventricular cardiac conduction conditions. In clinical trials, rivastigmine was not associated with any increased incidence of cardiovascular adverse events, heart rate or blood pressure changes, or ECG abnormalities. Syncopal episodes have been reported in 3% of patients receiving 6 mg to 12 mg per day of EXELON, compared to 2% of placebo patients.

Genitourinary Effects

Although not observed in clinical trials of rivastigmine, drugs that increase cholinergic activity may cause urinary obstruction.

Pulmonary Effects

Drugs that increase cholinergic activity, including rivastigmine, should be used with care in patients with a history of asthma or obstructive pulmonary disease.

5.4 Impairment in Driving or Use of Machinery

Dementia may cause gradual impairment of driving performance or compromise the ability to use machinery. The administration of rivastigmine may also result in adverse reactions that are detrimental to these functions. During treatment with the EXELON, routinely evaluate the patient's ability to continue driving or operating machinery.

6 ADVERSE REACTIONS

The following adverse reactions are described below and elsewhere in the labeling:

- Gastrointestinal Adverse Reactions [*see Warnings and Precautions (5.1)*].
- Allergic Dermatitis [*see Warnings and Precautions (5.2)*].
- Other Adverse Reactions from Increased Cholinergic Activity [*see Warnings and Precautions (5.3)*].

6.1 Clinical Trials Experience

Because clinical trials are conducted under widely varying conditions, adverse reaction rates observed in the clinical trials of a drug cannot be directly compared to rates in the clinical trials of another drug and may not reflect the rates observed in practice.

EXELON has been administered to over 5,297 individuals during clinical trials worldwide. Of these, 4,326 patients have been treated for at least 3 months, 3,407 patients have been treated for at least 6 months, 2,150 patients have been treated for 1 year, 1,250 patients have been treated for 2 years, and 168 patients have been treated for over 3 years. With regard to exposure to the highest dose, 2,809 patients were exposed to doses of 10 mg to 12 mg, 2,615 patients treated for 3 months, 2,328 patients treated for 6 months, 1,378 patients treated for 1 year, 917 patients treated for 2 years, and 129 patients treated for over 3 years.

Mild to Moderate Alzheimer's Disease

Most Common Adverse Reactions

The most common adverse reactions, defined as those occurring at a frequency of at least 5% and twice the placebo rate, are largely predicted by EXELON's cholinergic effects. These include nausea, vomiting, anorexia, dyspepsia, and asthenia.

Gastrointestinal Adverse Reactions

EXELON use is associated with significant nausea, vomiting, and weight loss [*see Warnings and Precautions (5.1)*].

Discontinuation Rates

The rate of discontinuation due to adverse events in controlled clinical trials of EXELON (rivastigmine tartrate) was 15% for patients receiving 6 mg to 12 mg per day compared to 5% for patients on placebo during forced weekly dose titration. While on a maintenance dose, the rates were 6% for patients on EXELON compared to 4% for those on placebo.

The most common adverse reactions leading to discontinuation, defined as those occurring in at least 2% of patients and at twice the incidence seen in placebo patients, are shown in Table 1.

Table 1 Most Frequent Adverse Reactions Leading to Withdrawal from Clinical Trials during Titration and Maintenance in Patients Receiving 6 mg to 12 mg per day EXELON Using a Forced-Dose Titration

Study Phase	Titration		Maintenance		Overall	
	EXELON	Placebo	EXELON	Placebo	EXELON	Placebo
	≥6–12 mg/day (n=1,189)	(n=868)	≥6–12 mg/day (n=987)	(n=788)	≥6–12 mg/day (n=1,189)	(n=868)
Event/% Discontinuing						
Nausea	8	<1	1	<1	8	1
Vomiting	4	<1	1	<1	5	<1
Anorexia	2	0	1	<1	3	<1
Dizziness	2	<1	1	<1	2	<1

Adverse Reactions Observed at an Incidence of at Least 2%

Table 2 lists adverse reactions that occurred in at least 2% of patients in placebo-controlled trials and for which the rate of occurrence was greater for patients treated with EXELON doses of 6 mg to 12 mg per day than for those treated with placebo.

In general, adverse reactions were less frequent later in the course of treatment.

No systematic effect of race or age could be determined from the incidence of adverse reactions in the controlled studies. Nausea, vomiting and weight loss were more frequent in women than men.

Table 2 Proportion of Adverse Reactions Observed with a Frequency of ≥2% and at a Rate Greater than Placebo in Clinical Trials

Body System/Adverse Reaction	EXELON (6–12 mg/day) (n=1,189)	Placebo (n=868)
Percent of Patients with any Adverse Event	92	79
Autonomic Nervous System		
Increased Sweating	4	1
Syncope	3	2
Body as a Whole		
Fatigue	9	5
Asthenia	6	2
Malaise	5	2
Decreased Weight**	3	<1
Cardiovascular Disorders, General		
Hypertension	3	2
Central and Peripheral Nervous System		
Dizziness	21	11
Headache	17	12
Somnolence	5	3
Tremor	4	1
Gastrointestinal System		

Nausea*	47	12
Vomiting*	31	6
Diarrhea	19	11
Anorexia***	17	3
Abdominal Pain	13	6
Dyspepsia	9	4
Psychiatric Disorders		
Insomnia	9	7
Confusion	8	7
Depression	6	4
Anxiety	5	3
Hallucination	4	3
Aggressive Reaction	3	2
Resistance Mechanism Disorders		
Urinary Tract Infection	7	6

*Nausea and Vomiting: In the controlled clinical trials, 47% of the patients treated with an EXELON dose in the therapeutic range of 6 mg to 12 mg per day (n=1189) developed nausea (compared with 12% in placebo). A total of 31% of EXELON-treated patients developed at least 1 episode of vomiting (compared with 6% for placebo). The rate of vomiting was higher during the titration phase (24% versus 3% for placebo) than in the maintenance phase (14% versus 3% for placebo). The rates were higher in women than men. Five percent of patients discontinued for vomiting, compared to less than 1% for patients on placebo. Vomiting was severe in 2% of EXELON-treated patients and was rated as mild or moderate each in 14% of patients. The rate of nausea was higher during the titration phase (43% versus 9% for placebo) than in the maintenance phase (17% versus 4% for placebo).

**Weight Decreased: In the controlled trials, approximately 26% of women on high doses of EXELON (greater than 9 mg per day) had weight loss equal to or greater than 7% of their baseline weight compared to 6% in the placebo-treated patients. About 18% of the males in the high-dose group experienced a similar degree of weight loss compared to 4% in placebo-treated patients. It is not clear how much of the weight loss was associated with anorexia, nausea, vomiting, and the diarrhea associated with the drug.

***Anorexia: In the controlled clinical trials, of the patients treated with an EXELON dose of 6 mg to 12 mg per day, 17% developed anorexia compared to 3% of the placebo patients. Neither the time course nor the severity of the anorexia is known.

Mild to Moderate Parkinson's Disease Dementia

EXELON has been administered to 779 individuals during clinical trials worldwide. Of these, 663 patients have been treated for at least 3 months, 476 patients have been treated for at least 6 months, and 313 patients have been treated for 1 year.

Most Common Adverse Reactions

The most common adverse reactions, defined as those occurring at a frequency of at least 5% and twice the placebo rate, are largely predicted by EXELON's cholinergic effects. These include nausea, vomiting, tremor, anorexia, and dizziness.

Discontinuation Rates

The rate of discontinuation due to adverse events in the single placebo-controlled trial of EXELON was 18% for patients receiving 3 mg to 12 mg per day compared to 11% for patients on placebo during the 24-week study.

The most frequent adverse reactions that led to discontinuation from this study, defined as those occurring in at least 1% of patients receiving EXELON and more frequent than those receiving placebo, were nausea (3.6% EXELON versus 0.6% placebo), vomiting (1.9% EXELON versus 0.6% placebo), and tremor (1.7% EXELON versus 0.0% placebo).

Adverse Reactions Observed at an Incidence of at Least 2%

Table 3 lists adverse reactions that occurred in at least 2% of patients in a single placebo-controlled trial and during the first 24 weeks of a 76-week open-label active-controlled trial for which the rate of occurrence was greater for patients treated with EXELON doses of 3 mg to 12 mg per day than for those treated with placebo in the placebo-controlled trial.

In general, adverse reactions were less frequent later in the course of treatment.

Table 3 Proportion of Adverse Reactions Observed at a Frequency $\geq 2\%$ and Occurring at Rate Greater than Placebo in Clinical Trials

Body System/Adverse Reaction	Active-Controlled Study	Placebo-Controlled Study	
	EXELON (3–12 mg/day) (n=294)	EXELON (3–12 mg/day) (n=362)	Placebo (n=179)
Percent of Patients with any Adverse Event	88	84	71
Gastrointestinal Disorders			
Nausea	38	29	11
Vomiting	13	17	2
Diarrhea	8	7	4
Upper Abdominal Pain	4	4	1
Salivary hypersecretion	2	1	0
General Disorders and Administrative Site Conditions			
Fall	10	6	6
Fatigue	5	4	3
Asthenia	4	2	1
Metabolism and Nutritional Disorders			
Anorexia	-	6	3
Decreased Appetite	5	8	5
Dehydration	1	2	1
Nervous System Disorders			
Tremor	23	10	4
Dizziness	8	6	1
Headache	4	4	3
Somnolence	6	4	3
Parkinson's Disease (worsening)	-*	3	1
Bradykinesia	3	3	2
Dyskinesia	3	1	1
Cogwheel rigidity	3	1	0
Hypokinesia	2	1	0
Parkinsonism	-	2	1
Psychiatric Disorders			
Anxiety	4	4	1
Insomnia	2	3	2
Restlessness	1	3	2
Skin and Subcutaneous Tissue Disorders			
Increased Sweating	2	2	1

*Parkinson's disease (worsening) in the active-controlled study was assessed by reported pre-identified adverse events (tremor, cogwheel rigidity, fall), each of them listed with corresponding frequencies.

6.2 Postmarketing Experience

The following adverse reactions have been identified during post approval use of EXELON. Because these reactions are reported voluntarily from a population of uncertain size, it is not always possible to reliably estimate their frequency or establish a causal relationship to drug exposure.

Hepatobiliary Disorders: Hepatitis.

Psychiatric Disorders: Aggression.

Skin and Appendages: Stevens-Johnson syndrome, disseminated allergic dermatitis.

7 DRUG INTERACTIONS

7.1 Metoclopramide

Due to the risk of additive extrapyramidal adverse reactions, the concomitant use of metoclopramide and EXELON is not recommended.

7.2 Cholinomimetic and Anticholinergic Medications

EXELON may increase the cholinergic effects of other cholinomimetic medications and may also interfere with the activity of anticholinergic medications (e.g., oxybutynin, tolterodine). Concomitant use of EXELON with medications having these pharmacologic effects is not recommended unless deemed clinically necessary [*see Warnings and Precautions (5.3)*].

7.3 Beta-blockers

Additive bradycardic effects resulting in syncope may occur when EXELON is used concomitantly with beta-blockers, especially cardioselective beta-blockers (including atenolol). Concomitant use of EXELON with beta-blockers is not recommended.

8 USE IN SPECIFIC POPULATIONS

8.1 Pregnancy

Pregnancy Category B

There are no adequate and well-controlled studies in pregnant women. Reproduction studies conducted in pregnant rats and rabbits at oral doses up to 2.3 mg-base/kg/day, or 2 (rat) and 4 (rabbit) times the maximum recommended human dose (MRHD) of 12 mg per day on a mg/m² basis, revealed no evidence of teratogenicity. Because animal reproduction studies are not always predictive of human response, this drug should be used during pregnancy only if clearly needed.

8.3 Nursing Mothers

Rivastigmine and its metabolites are excreted in rat milk following oral administration of rivastigmine; levels of rivastigmine plus metabolites in rat milk are approximately 2 times that in maternal plasma. It is not known whether rivastigmine is excreted in human milk. Because many drugs are excreted in human milk and because of the potential for serious adverse reactions in nursing infants from EXELON, a decision should be made whether to discontinue nursing or to discontinue the drug, taking into account the importance of the drug to the mother.

8.4 Pediatric Use

Safety and effectiveness in pediatric patients have not been established. The use of EXELON in pediatric patients (below 18 years of age) is not recommended.

8.5 Geriatric Use

Of the total number of patients in clinical studies of EXELON, 86 percent were 65 years and older while 46 percent were 75 years and older. No overall differences in safety or effectiveness were observed between these patients and younger patients, and other reported clinical experience has not identified differences in responses between the elderly and younger patients, but greater sensitivity of some older individuals cannot be ruled out.

8.6 Renal Impairment

Patients with moderate to severe renal impairment may be able to only tolerate lower doses [see *Dosage and Administration (2.3) and Clinical Pharmacology (12.3)*].

8.7 Hepatic Impairment

Patients with mild or moderate hepatic impairment may be able to only tolerate lower doses [see *Dosage and Administration (2.3) and Clinical Pharmacology (12.3)*]. No data are available on the use of EXELON in patients with severe hepatic impairment.

8.8 Low or High Body Weight

Because rivastigmine blood levels vary with weight, careful titration and monitoring should be performed in patients with low or high body weights [see *Dosage and Administration (2.3) and Clinical Pharmacology (12.3)*].

10 OVERDOSAGE

Because strategies for the management of overdose are continually evolving, it is advisable to contact a Poison Control Center to determine the latest recommendations for the management of an overdose of any drug.

As rivastigmine has a short plasma half-life of about 1 hour and a moderate duration of acetylcholinesterase inhibition of 8 to 10 hours, it is recommended that in cases of asymptomatic overdoses, no further dose of EXELON should be administered for the next 24 hours.

As in any case of overdose, general supportive measures should be utilized.

Overdosage with cholinesterase inhibitors can result in cholinergic crisis characterized by severe nausea, vomiting, salivation, sweating, bradycardia, hypotension, respiratory depression, collapse and convulsions. Increasing muscle weakness is a possibility and may result in death if respiratory muscles are involved. Atypical responses in blood pressure and heart rate have been reported with other drugs that increase cholinergic activity when coadministered with quaternary anticholinergics such as glycopyrrolate. Additional symptoms associated with rivastigmine overdose are diarrhea, abdominal pain, dizziness, tremor, headache, somnolence, confusional state, hyperhidrosis, hypertension, hallucinations and malaise. Due to the short half-life of rivastigmine, dialysis (hemodialysis, peritoneal dialysis, or hemofiltration) would not be clinically indicated in the event of an overdose.

In overdoses accompanied by severe nausea and vomiting, the use of antiemetics should be considered. A fatal outcome has been rarely reported with rivastigmine..

11 DESCRIPTION

EXELON (rivastigmine tartrate) is a reversible cholinesterase inhibitor and is known chemically as (S)-N-Ethyl-N-methyl-3-[1-(dimethylamino)ethyl]-phenyl carbamate hydrogen-(2R,3R)-tartrate. Rivastigmine tartrate is commonly referred to in the pharmacological literature as SDZ ENA 713 or ENA 713. It has an empirical formula of $C_{14}H_{22}N_2O_2 \cdot C_4H_6O_6$ (hydrogen tartrate salt-hta salt) and a molecular weight of 400.43 (hta salt). Rivastigmine tartrate is a white to off-white, fine crystalline powder that is very soluble in water, soluble in ethanol and acetonitrile, slightly soluble in n-octanol and very slightly soluble in ethyl acetate.

The distribution coefficient at 37°C in n-octanol/phosphate buffer solution pH 7 is 3.0.

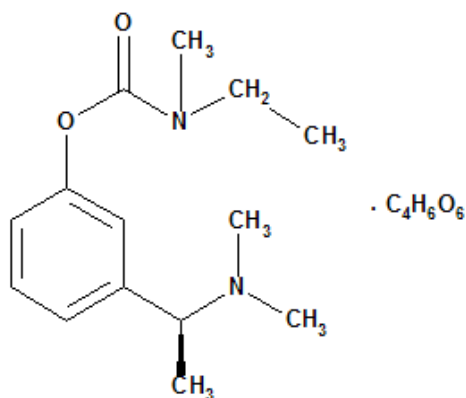

EXELON Capsules contain rivastigmine tartrate, equivalent to 1.5 mg, 3 mg, 4.5 mg, and 6 mg of rivastigmine base for oral administration. Inactive ingredients are hydroxypropyl methylcellulose, magnesium stearate, microcrystalline cellulose, and silicon dioxide. Each hard-gelatin capsule contains gelatin, titanium dioxide and red and/or yellow iron oxides.

EXELON Oral Solution is supplied as a solution containing rivastigmine tartrate, equivalent to 2 mg/mL of rivastigmine base for oral administration. Inactive ingredients are citric acid, D&C yellow #10, purified water, sodium benzoate and sodium citrate.

12 CLINICAL PHARMACOLOGY

12.1 Mechanism of Action

Although the precise mechanism of action of rivastigmine is unknown, it is thought to exert its therapeutic effect by enhancing cholinergic function. This is accomplished by increasing the concentration of acetylcholine through reversible inhibition of its hydrolysis by cholinesterase. Therefore, the effect of rivastigmine may lessen as the disease process advances and fewer cholinergic neurons remain functionally intact. There is no evidence that rivastigmine alters the course of the underlying dementing process.

12.2 Pharmacodynamics

After a 6-mg dose of rivastigmine, anticholinesterase activity is present in cerebrospinal fluid (CSF) for about 10 hours, with a maximum inhibition of about 60% 5 hours after dosing.

In vitro and *in vivo* studies demonstrate that the inhibition of cholinesterase by rivastigmine is not affected by the concomitant administration of memantine, an N-methyl-D-aspartate receptor antagonist.

12.3 Pharmacokinetics

Rivastigmine shows linear pharmacokinetics up to 3 mg twice a day but is nonlinear at higher doses. Doubling the dose from 3 mg to 6 mg twice a day results in a 3-fold increase in AUC. The elimination half-life is about 1.5 hours, with most elimination as metabolites via the urine.

Absorption

Rivastigmine is rapidly and completely absorbed. Peak plasma concentrations are reached in approximately 1 hour. Absolute bioavailability after a 3-mg dose is about 36%. Administration of EXELON with food delays absorption (t_{\max}) by 90 minutes lowers C_{\max} by approximately 30% and increases AUC by approximately 30%.

Distribution

Rivastigmine is weakly bound to plasma proteins (approximately 40%) over the therapeutic range. It readily crosses the blood-brain barrier, reaching CSF peak concentrations in 1.4 to 2.6 hours. It has an apparent volume of distribution in the range of 1.8 to 2.7 L/kg.

Metabolism

Rivastigmine is rapidly and extensively metabolized, primarily via cholinesterase-mediated hydrolysis to the decarbamylated metabolite. Based on evidence from *in vitro* and animal studies, the major cytochrome P450 isozymes are minimally involved in rivastigmine metabolism. Consistent with these observations is the finding that no drug interactions related to cytochrome P450 have been observed in humans

Elimination

The major pathway of elimination is via the kidneys. Following administration of ¹⁴C-rivastigmine to 6 healthy volunteers, total recovery of radioactivity over 120 hours was 97% in urine and 0.4% in feces. No parent drug was detected in urine. The sulfate conjugate of the decarbamylated metabolite is the major component excreted in urine and represents 40% of the dose. Mean oral clearance of rivastigmine is 1.8 ± 0.6 L/min after 6 mg twice a day.

Age

Following a single 2.5-mg oral dose to elderly volunteers (60 years and older, n=24) and younger volunteers (n=24), mean oral clearance of rivastigmine was 30% lower in elderly (7 L/min) than in younger subjects (10 L/min).

Gender and Race

Population pharmacokinetic analysis of oral rivastigmine indicated that neither gender (n=277 males and 348 females) nor race (n=575 Caucasian, 34 Black, 4 Asian, and 12 Other) affected clearance of the drug.

Body Weight

A relationship between drug exposure at steady-state (rivastigmine and metabolite NAP226-90) and body weight was observed in Alzheimer's dementia patients. Rivastigmine exposure is higher in subjects with low body weight. Compared to a patient with a body weight of 65 kg, the rivastigmine steady-state concentrations in a patient with a body weight of 35 kg would be approximately doubled, while for a patient with a body weight of 100 kg the concentrations would be approximately halved.

Renal Impairment

Following a single 3-mg dose, mean oral clearance of rivastigmine is 64% lower in moderately impaired renal patients (n=8, GFR=10 to 50 mL/min) than in healthy subjects (n=10, GFR ≥60 mL/min); Cl/F=1.7 L/min and 4.8 L/min, respectively. In patients with severe renal impairment (n=8, GFR <10 mL/min), mean oral clearance of rivastigmine is 43% higher than in healthy subjects (n=10, GFR ≥60 mL/min); Cl/F=6.9 L/min and 4.8 L/min, respectively. For unexplained reasons, the severely impaired renal patients had a higher clearance of rivastigmine than moderately impaired patients.

Hepatic Impairment

Following a single 3-mg dose, mean oral clearance of rivastigmine was 60% lower in hepatically impaired patients (n=10, biopsy proven) than in healthy subjects (n=10). After multiple 6-mg twice a day oral dosing, the mean clearance of rivastigmine was 65% lower in mild (n=7, Child-Pugh score 5 to 6) and moderate (n=3, Child-Pugh score 7 to 9) hepatically impaired patients (biopsy proven, liver cirrhosis) than in healthy subjects (n=10).

Smoking

Following oral rivastigmine administration (upto 12 mg/day) with nicotine use, population pharmacokinetic analysis showed increased oral clearance of rivastigmine by 23% (n=75 smokers and 549 nonsmokers).

Drug Interaction Studies

Effect of Rivastigmine on the Metabolism of Other Drugs

Rivastigmine is primarily metabolized through hydrolysis by esterases. Minimal metabolism occurs via the major cytochrome P450 isoenzymes. Based on *in vitro* studies, no pharmacokinetic drug interactions with drugs metabolized by the following isoenzyme systems are expected: CYP1A2, CYP2D6, CYP3A4/5, CYP2E1, CYP2C9, CYP2C8, CYP2C19, or CYP2B6.

No pharmacokinetic interaction was observed between rivastigmine taken orally and digoxin, warfarin, diazepam or fluoxetine in studies in healthy volunteers. The increase in prothrombin time induced by warfarin is not affected by administration of rivastigmine.

Effect of Other Drugs on the Metabolism of Rivastigmine

Drugs that induce or inhibit CYP450 metabolism are not expected to alter the metabolism of rivastigmine.

Population pharmacokinetic analysis with a database of 625 patients showed that the pharmacokinetics of rivastigmine taken orally were not influenced by commonly prescribed medications such as antacids (n=77), antihypertensives (n=72), beta-blockers (n=42), calcium channel blockers (n=75), antidiabetics (n=21), NSAIDs (n=79), estrogens (n=70), salicylate analgesics (n=177), antianginals (n=35) and antihistamines (n=15).

13 NONCLINICAL TOXICOLOGY

13.1 Carcinogenesis, Mutagenesis, Impairment of Fertility

Carcinogenesis

In oral carcinogenicity studies conducted at doses up to 1.1 mg-base/kg/day in rats and 1.6 mg-base/kg/day in mice, rivastigmine was not carcinogenic. These doses are less than the maximum recommended human dose (MRHD) of 12 mg per day on a mg/m² basis.

Mutagenesis

Rivastigmine was clastogenic in *in vitro* chromosomal aberration assays in mammalian cells in the presence, but not the absence, of metabolic activation. Rivastigmine was negative in an *in vitro* bacterial reverse mutation (Ames) assay, an *in vitro* HGPRT assay, and in an *in vivo* mouse micronucleus test.

Impairment of Fertility

Rivastigmine had no effect on fertility or reproductive performance in rats at oral doses up to 1.1 mg-base/kg/day, a dose less than the MRHD on a mg/m² basis.

14 CLINICAL STUDIES

Mild to Moderate Alzheimer's Disease

The effectiveness of EXELON as a treatment for Alzheimer's disease is demonstrated by the results of 2 randomized, double-blind, placebo-controlled clinical investigations (*Study 1 and Study 2*) in patients with Alzheimer's disease [diagnosed by NINCDS-ADRDA and DSM-IV criteria, Mini-Mental State Examination (MMSE) ≥ 10 and ≤ 26 , and the Global Deterioration Scale (GDS)]. The mean age of patients participating in EXELON trials was 73 years with a range of 41 to 95. Approximately 59% of patients were women and 41% were men. The racial distribution was Caucasian 87%, Black 4%, and other races 9%.

In each study, the effectiveness of EXELON was evaluated using a dual outcome assessment strategy.

The ability of EXELON to improve cognitive performance was assessed with the cognitive subscale of the Alzheimer's Disease Assessment Scale (ADAS-cog), a multi-item instrument that has been extensively validated in longitudinal cohorts of Alzheimer's disease patients. The ADAS-cog examines selected aspects of cognitive performance including elements of memory, orientation, attention, reasoning, language, and praxis. The ADAS-cog scoring range is from 0 to 70, with higher scores indicating greater cognitive impairment. Elderly normal adults may score as low as 0 or 1, but it is not unusual for non-demented adults to score slightly higher.

The patients recruited as participants in each study had mean scores on ADAS-cog of approximately 23 units, with a range from 1 to 61. Experience gained in longitudinal studies of ambulatory patients with mild to moderate Alzheimer's disease suggests that they gain 6 to 12 units a year on the ADAS-cog. Lesser degrees of change, however, are seen in patients with very mild or very advanced disease because the ADAS-cog is not uniformly sensitive to change over the course of the disease. The annualized rate of decline in the placebo patients participating in EXELON trials was approximately 3 to 8 units per year.

The ability of EXELON to produce an overall clinical effect was assessed using a Clinician's Interview-Based Impression of Change (CIBIC) that required the use of caregiver information, the CIBIC-Plus. The CIBIC-Plus is not a single instrument and is not a standardized instrument like the ADAS-cog. Clinical trials for investigational drugs have used a variety of CIBIC formats, each different in terms of depth and structure. As such, results from a CIBIC-Plus reflect clinical experience from the trial or trials in which it was used and cannot be compared directly with the results of CIBIC-Plus evaluations from other clinical trials. The CIBIC-Plus used in the EXELON trials was a structured instrument based on a comprehensive evaluation at baseline and subsequent time-points of 3 domains: patient cognition, behavior and functioning, including assessment of activities of daily living. It represents the assessment of a skilled clinician using

validated scales based on his/her observation at interviews conducted separately with the patient and the caregiver familiar with the behavior of the patient over the interval rated. The CIBIC-Plus is scored as a 7-point categorical rating, ranging from a score of 1, indicating "markedly improved," to a score of 4, indicating "no change" to a score of 7, indicating "marked worsening." The CIBIC-Plus has not been systematically compared directly to assessments not using information from caregivers or other global methods.

U.S. 26-Week Study of EXELON in Mild to Moderate Alzheimer's Disease (Study 1)

In a study of 26 weeks duration, 699 patients were randomized to either a dose range of 1 mg to 4 mg or 6 mg to 12 mg of EXELON per day or to placebo, each given in divided doses. The 26-week study was divided into a 12-week forced-dose titration phase and a 14-week maintenance phase. The patients in the active treatment arms of the study were maintained at their highest tolerated dose within the respective range.

Figure 1 illustrates the time course for the change from baseline in ADAS-cog scores for all 3 dose groups over the 26 weeks of the study. At 26 weeks of treatment, the mean differences in the ADAS-cog change scores for the EXELON-treated patients compared to the patients on placebo were 1.9 and 4.9 units for the 1 mg to 4 mg and 6 mg to 12 mg treatments, respectively. Both treatments were statistically significantly superior to placebo and the 6 mg to 12 mg per day range was significantly superior to the 1 mg to 4 mg per day range.

Figure 1 Time-course of the Change from Baseline in ADAS-cog Score for Patients Completing 26 Weeks of Treatment in Study 1

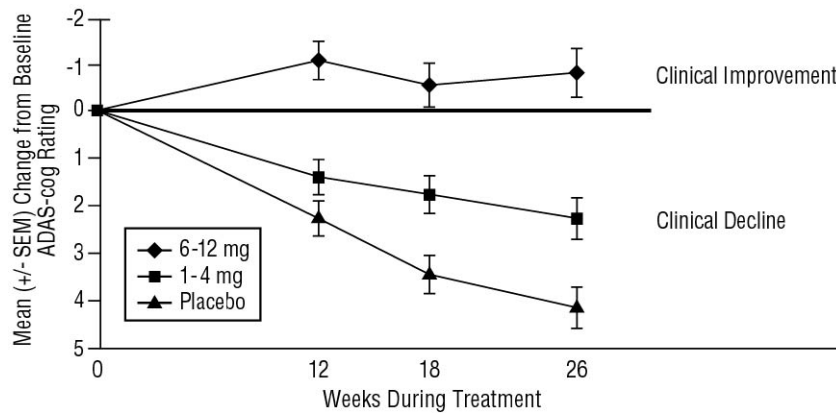

Figure 2 illustrates the cumulative percentages of patients from each of the 3 treatment groups who had attained at least the measure of improvement in ADAS-cog score shown on the X-axis. Three change scores, (7-point and 4-point reductions from baseline or no change in score) have been identified for illustrative purposes, and the percent of patients in each group achieving that result is shown in the inset table.

The curves demonstrate that both patients assigned to EXELON and placebo have a wide range of responses, but that the EXELON groups are more likely to show the greater improvements. A curve for an effective treatment would be shifted to the left of the curve for placebo, while an ineffective or deleterious treatment would be superimposed upon, or shifted to the right of the curve for placebo, respectively.

Figure 2 Cumulative Percentage of Patients Completing 26 Weeks of Double-blind Treatment with Specified Changes from Baseline ADAS-cog Scores. The Percentages of Randomized Patients who Completed the Study were: Placebo 84%, 1 mg – 4 mg 85%, and 6 mg –12 mg 65%.

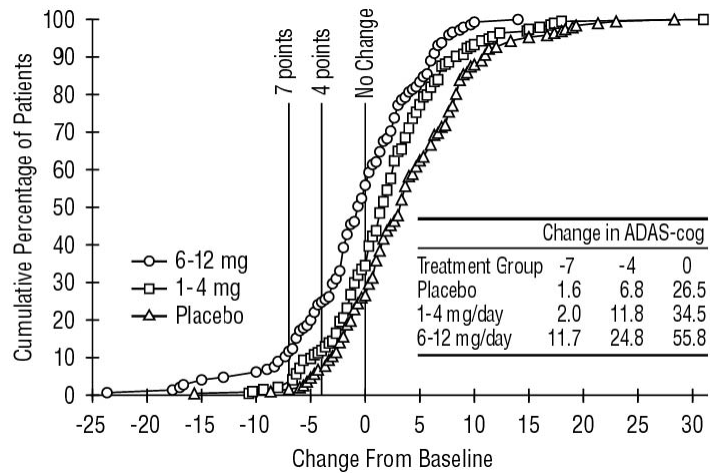
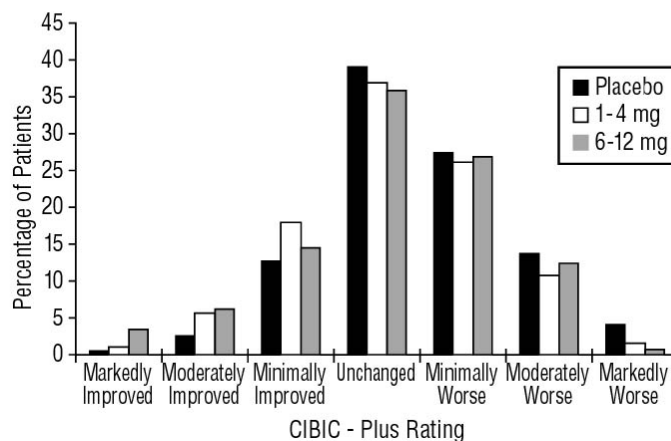

Figure 3 is a histogram of the frequency distribution of CIBIC-Plus scores attained by patients assigned to each of the 3 treatment groups who completed 26 weeks of treatment. The mean EXELON-placebo differences for these groups of patients in the mean rating of change from baseline were 0.32 units and 0.35 units for 1 mg to 4 mg and 6 mg to 12 mg of EXELON, respectively. The mean ratings for the 6 mg to 12 mg per day and 1 mg to 4 mg per day groups were statistically significantly superior to placebo. The differences between the 6 mg to 12 mg per day and the 1 mg to 4 mg per day groups were statistically significant.

Figure 3 Frequency Distribution of CIBIC-Plus Scores at Week 26 in Study 1



Global 26-Week Study in Mild to Moderate Alzheimer’s Disease (Study 2)

In a second study of 26 weeks duration, 725 patients were randomized to either a dose range of 1 mg to 4 mg or 6 mg to 12 mg of EXELON per day or to placebo, each given in divided doses. The 26-week study was divided into a 12-week forced-dose titration phase and a 14-week maintenance phase. The patients in the active treatment arms of the study were maintained at their highest tolerated dose within the respective range.

Figure 4 illustrates the time course for the change from baseline in ADAS-cog scores for all 3 dose groups over the 26 weeks of the study. At 26 weeks of treatment, the mean differences in the ADAS-cog change scores for the EXELON-treated patients compared to the patients on placebo were 0.2 and 2.6 units for the 1 mg to 4 mg and 6 mg to 12 mg

treatments, respectively. The 6 mg to 12 mg per day group was statistically significantly superior to placebo, as well as to the 1 mg to 4 mg per day group. The difference between the 1 mg to 4 mg per day group and placebo was not statistically significant.

Figure 4 Time-course of the Change from Baseline in ADAS-cog Score for Patients Completing 26 Weeks of Treatment

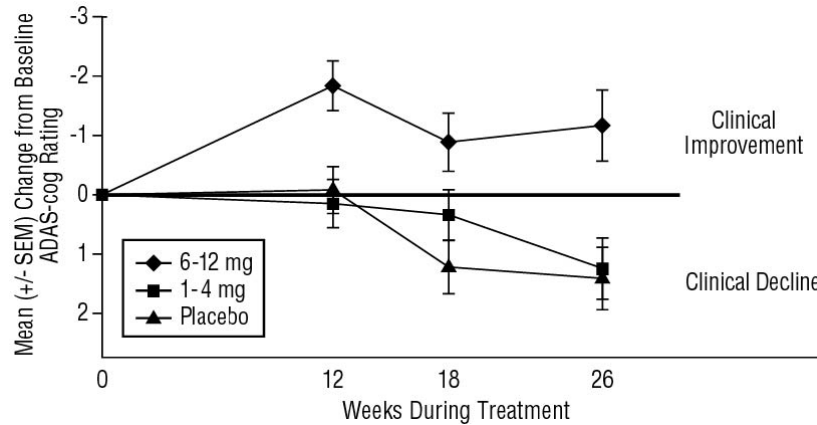

Figure 5 illustrates the cumulative percentages of patients from each of the 3 treatment groups who had attained at least the measure of improvement in ADAS-cog score shown on the X-axis. Similar to the U.S. 26-week study, the curves demonstrate that both patients assigned to EXELON and placebo have a wide range of responses, but that the 6 mg to 12 mg per day EXELON group is more likely to show the greater improvements.

Figure 5 Cumulative Percentage of Patients Completing 26 Weeks of Double-blind Treatment with Specified Changes from Baseline ADAS-cog Scores. The Percentages of Randomized Patients who Completed the Study were: Placebo 87%, 1 mg-4 mg 86%, and 6 mg-12 mg 67%.

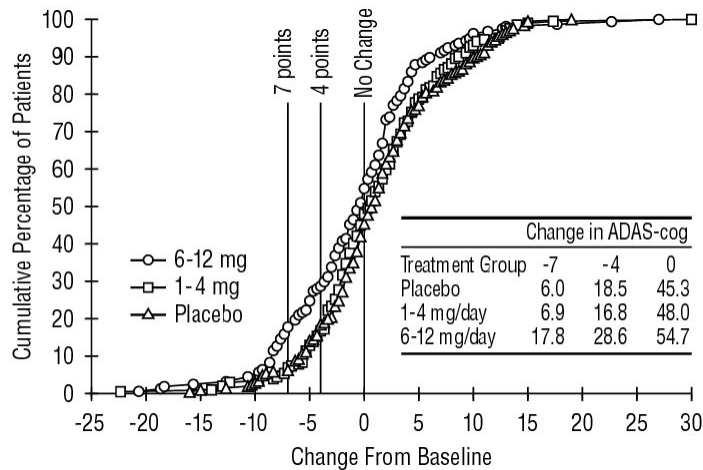
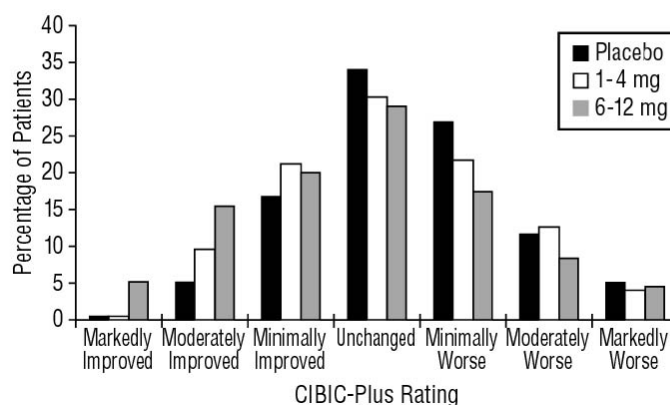

Figure 6 is a histogram of the frequency distribution of CIBIC-Plus scores attained by patients assigned to each of the 3 treatment groups who completed 26 weeks of treatment. The mean EXELON-placebo differences for these groups of patients for the mean rating of change from baseline were 0.14 units and 0.41 units for 1 mg to 4 mg and 6 mg to 12 mg of EXELON, respectively. The mean ratings for the 6 mg to 12 mg per day group were statistically significantly superior to placebo. The comparison of the mean ratings for the 1 mg to 4 mg per day group and placebo group was not statistically significant.

Figure 6 Frequency Distribution of CIBIC-Plus Scores at Week 26 in Study 2



U.S. Fixed-Dose Study in Mild to Moderate Alzheimer's Disease (Study 3)

In a study of 26 weeks duration, 702 patients were randomized to doses of 3 mg, 6 mg, or 9 mg per day of EXELON or to placebo, each given in divided doses. The fixed-dose study design, which included a 12-week forced-dose titration phase and a 14-week maintenance phase, led to a high dropout rate in the 9 mg per day group because of poor tolerability. At 26 weeks of treatment, significant differences were observed for the ADAS-cog mean change from baseline for the 9 mg per day and 6 mg per day groups, compared to placebo. No significant differences were observed between any of the EXELON-dose groups and placebo for the analysis of the CIBIC-Plus mean rating of change. Although no significant differences were observed between EXELON treatment groups, there was a trend toward numerical superiority with higher doses.

Mild to Moderate Parkinson's Disease Dementia

International 24-Week Study (Study 4)

The effectiveness of EXELON as a treatment for dementia associated with Parkinson's disease is demonstrated by the results of 1 randomized, double-blind, placebo-controlled clinical investigation in patients with mild to moderate dementia, with onset at least 2 years after the initial diagnosis of idiopathic Parkinson's disease. The diagnosis of idiopathic Parkinson's disease was based on the United Kingdom Parkinson's Disease Society Brain Bank clinical criteria. The diagnosis of dementia was based on the criteria stipulated under the DSM-IV category "Dementia Due To Other General Medical Condition" (code 294.1x), but patients were not required to have a distinctive pattern of cognitive deficits as part of the dementia. Alternate causes of dementia were excluded by clinical history, physical and neurological examination, brain imaging, and relevant blood tests. Patients enrolled in the study had a MMSE score ≥ 10 and ≤ 24 at entry. The mean age of patients participating in this trial was 72.7 years with a range of 50–91 years. Approximately, 35.1% of patients were women and 64.9% of patients were men. The racial distribution was 99.6% Caucasian and other races 0.4%.

This study used a dual outcome assessment strategy to evaluate the effectiveness of EXELON.

The ability of EXELON to improve cognitive performance was assessed with the ADAS-cog.

The ability of EXELON to produce an overall clinical effect was assessed using the Alzheimer's Disease Cooperative Study – Clinician's Global Impression of Change (ADCS-CGIC). The ADCS-CGIC is a more standardized form of CIBIC-Plus and is also scored as a 7-point categorical rating, ranging from a score of 1, indicating "markedly improved," to a score of 4, indicating "no change" to a score of 7, indicating "marked worsening".

In this study, 541 patients were randomized to a dose range of 3 mg to 12 mg of EXELON per day or to placebo in a ratio of 2:1, given in divided doses. The 24-week study was divided into a 16-week titration phase and an 8-week maintenance phase. The patients in the active treatment arm of the study were maintained at their highest tolerated dose within the specified dose range.

Figure 7 illustrates the time course for the change from baseline in ADAS-cog scores for both treatment groups over the 24-week study. At 24 weeks of treatment, the mean difference in the ADAS-cog change scores for the EXELON-treated patients compared to the patients on placebo was 3.8 points. This treatment difference was statistically significant in favor of EXELON when compared to placebo.

Figure 7 Time Course of the Change from Baseline in ADAS-cog Score for Patients Completing 24 Weeks of Treatment in Study 4

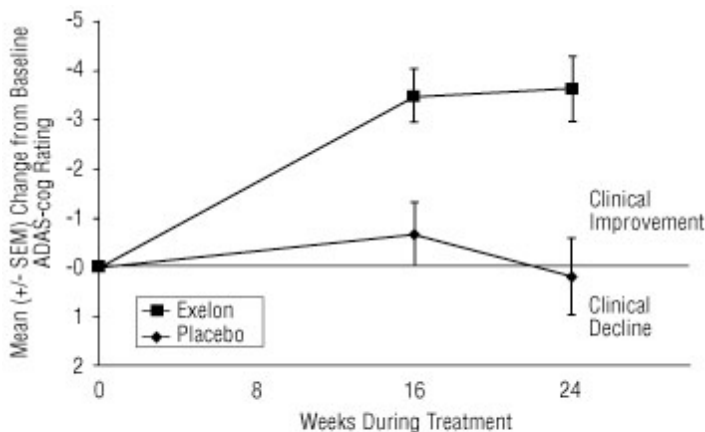
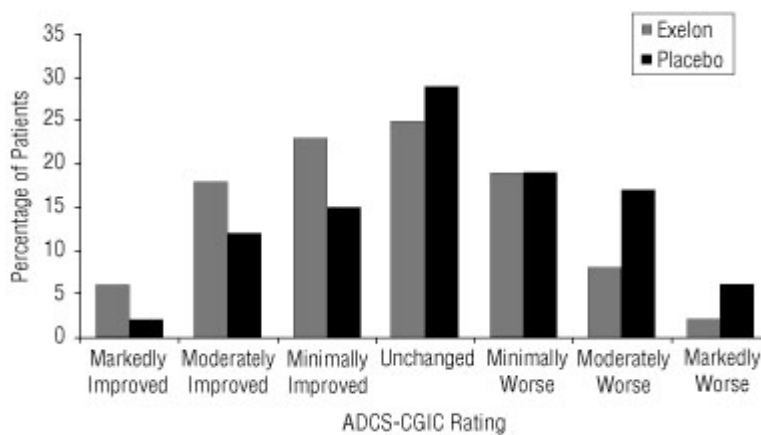

Figure 8 is a histogram of the distribution of patients' scores on the ADCS-CGIC (Alzheimer's Disease Cooperative Study - Clinician's Global Impression of Change) at 24 weeks. The mean difference in change scores between the EXELON and placebo groups from baseline was 0.5 points. This difference was statistically significant in favor of EXELON treatment.

Figure 8 Distribution of ADCS-CGIC Scores for Patients Completing 24 Weeks of Treatment in Study 4



Patients' age, gender, or race did not predict clinical outcome of EXELON treatment.

16 HOW SUPPLIED/STORAGE AND HANDLING

EXELON Capsules

EXELON (rivastigmine tartrate) Capsules equivalent to 1.5 mg, 3 mg, 4.5 mg, or 6 mg of rivastigmine base are available as follows:

1.5 mg capsule – yellow, “Exelon 1,5 mg” is printed in red on the body of the capsule.

Bottles of 60 NDC 0078-0323-44

Bottles of 500 NDC 0078-0323-08

Unit Dose (blister pack) Box of 100 (strips of 10) NDC 0078-0323-06

3 mg capsule – orange, “Exelon 3 mg” is printed in red on the body of the capsule.

Bottles of 60 NDC 0078-0324-44

Bottles of 500 NDC 0078-0324-08

Unit Dose (blister pack) Box of 100 (strips of 10) NDC 0078-0324-06

4.5 mg capsule – red, “Exelon 4,5 mg” is printed in white on the body of the capsule.

Bottles of 60 NDC 0078-0325-44

Bottles of 500 NDC 0078-0325-08

Unit Dose (blister pack) Box of 100 (strips of 10) NDC 0078-0325-06

6 mg capsule – orange and red, “Exelon 6 mg” is printed in red on the body of the capsule.

Bottles of 60 NDC 0078-0326-44

Bottles of 500 NDC 0078-0326-08

Unit Dose (blister pack) Box of 100 (strips of 10) NDC 0078-0326-06

Store at 25°C (77°F); excursions permitted to 15°C–30°C (59°F–86°F) [see USP Controlled Room Temperature]. Store in a tight container.

EXELON Oral Solution

EXELON (rivastigmine tartrate) Oral Solution is supplied as 120 mL of a clear, yellow solution (2 mg/mL base) in a 4-ounce USP Type III amber glass bottle with a child-resistant 19-mm linerless cap, dip tube and self-aligning plug. The oral solution is packaged with a dispenser set which consists of an assembled oral dosing syringe that allows dispensing a maximum volume of 3 mL corresponding to a 6-mg dose, with a plastic tube container.

Bottles of 120 mL NDC 0078-0339-31

Store at 25°C (77°F); excursions permitted to 15°C–30°C (59°F–86°F) [see USP Controlled Room Temperature]. Store in an upright position and protect from freezing.

When EXELON Oral Solution is combined with cold fruit juice or soda, the mixture is stable at room temperature for up to 4 hours.

17 PATIENT COUNSELING INFORMATION

Advise the patient to read the FDA-approved patient labeling (Instructions for Use).

Gastrointestinal Adverse Reactions

Caregivers should be advised of the high incidence of nausea and vomiting associated with the use of the drug along with the possibility of anorexia and weight loss. Caregivers should be encouraged to monitor for these adverse events and inform the physician if they occur. It is critical to inform caregivers that if therapy has been interrupted for more than several days, the next dose should not be administered until they have discussed this with the physician [see *Warnings and Precautions* (5.1)].

Skin Reactions

Caregivers and patients should be advised that allergic skin reactions have been reported in association with EXELON regardless of formulation (capsules, oral solution or transdermal patch). In case of skin reaction while taking EXELON, patients should consult with their physician immediately [*see Warnings and Precautions (5.2)*].

Importance of Correct Usage

Caregivers should be instructed in the correct procedure for administering EXELON Oral Solution. In addition, they should be informed of the existence of an Instruction Sheet (included with the product) describing how the solution is to be administered. They should be urged to read this sheet prior to administering EXELON Oral Solution. Caregivers should direct questions about the administration of the solution to either their physician or pharmacist. See EXELON Oral Solution Instructions for Use.

Concomitant Use of Drugs with Cholinergic Action

Caregivers and patients should be advised that cholinomimetics, including rivastigmine, may exacerbate or induce extrapyramidal symptoms. Worsening in patients with Parkinson's disease, including an increased incidence or intensity of tremor, has been observed [*see Warnings and Precautions (5.3)*].

T201X-XX
Month Year

Instructions for Use
Exelon (ECS-'el-on)
(rivastigmine tartrate)
Oral Solution

Instructions for using your Exelon Oral Solution

Read these instructions before taking Exelon Oral Solution and each time you get a refill. There may be new information. This information does not take the place of talking to your doctor about your medical condition or your treatment.

Preparing your dose of Exelon Oral Solution.

You will need the following supplies:

- Exelon Oral Solution Bottle
- Oral dosing syringe in protective case

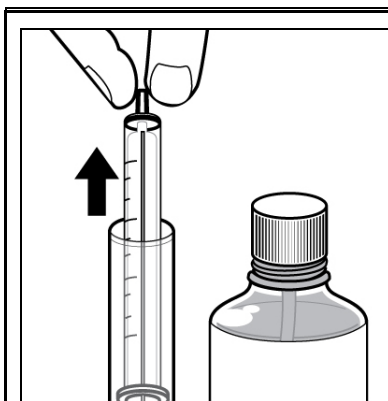
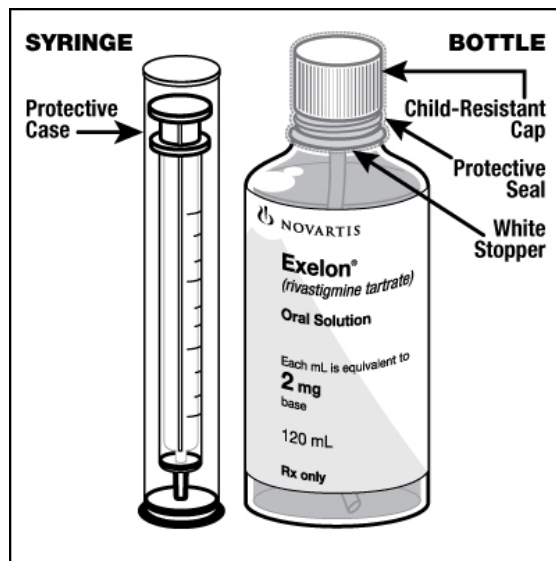

1. Remove the oral dosing syringe from its protective case.



2. Firmly push down and twist the child-resistant cap counter-clockwise to open the bottle.

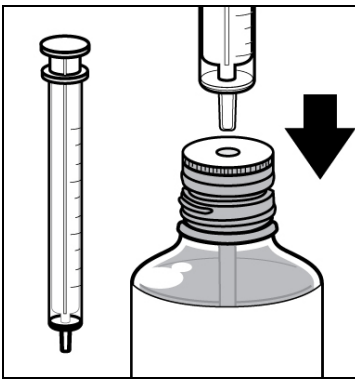

3. Keep the bottle upright on a firm table and insert tip of syringe into the opening of the white stopper.

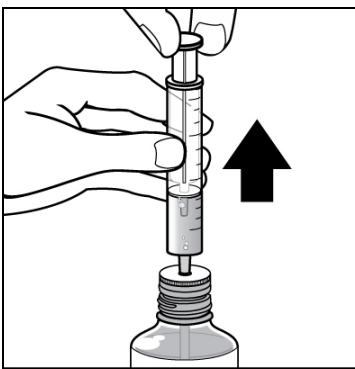

4. While holding the syringe in place, pull the plunger of the syringe up to the level (see markings on side of syringe) that equals the dose prescribed by your doctor.

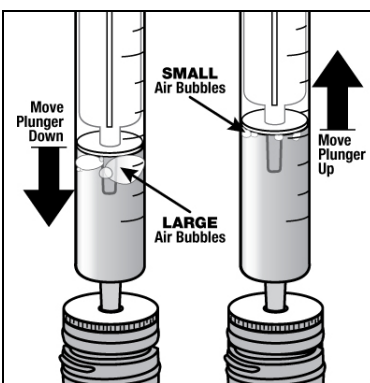

5. Before removing syringe with your prescribed dose from the bottle, push out any large bubbles by moving plunger up and down a few times.

- After the large bubbles are gone, pull the plunger again to the level that equals the dose prescribed by your doctor.
- Do not worry about a few tiny bubbles. This will not affect your dose.

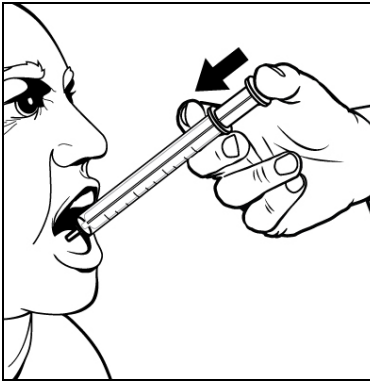

6. Remove the syringe from the bottle. You may swallow Exelon Oral Solution from the syringe or mix it with a small glass of water, cold fruit juice or soda.



mixing with liquid

- If mixing with water, cold fruit juice or soda, be sure to stir completely and to drink the all of the liquid.
- **Do not** mix Exelon Oral Solution with liquids other than water, cold fruit juice, or soda.

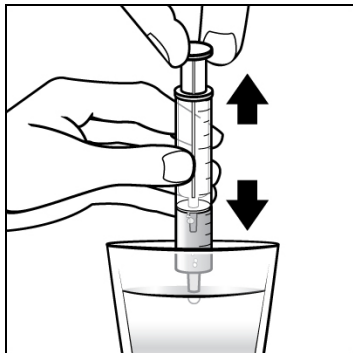

7. After use, rinse the empty syringe by inserting the open end of the syringe into a glass of water. Pull the plunger out to draw in water, and push the plunger in to remove the water. Repeat this several times. Allow the syringe to air dry and put it back into its case.



8. Place the child-resistant cap back on the bottle and store in an upright position.

How to Store Exelon Oral Solution:

- Store at room temperature between 68°F to 77°F (20°C to 25°C) in an upright position.
- After mixing with water, cold fruit juice, or soda, Exelon Oral Solution can be stored at room temperature for up to 4 hours before drinking.
- Do not store in freezer.

This Instructions for Use has been approved by the U.S. Food and Drug Administration.

Distributed by:

Novartis Pharmaceuticals Corporation

East Hanover, New Jersey 07936

© Novartis

T201X-XX/T2013-86

Month Year/October 2013